

LOCATION TO BE MOUNTED (80°, 90° OR 100° OPENING)

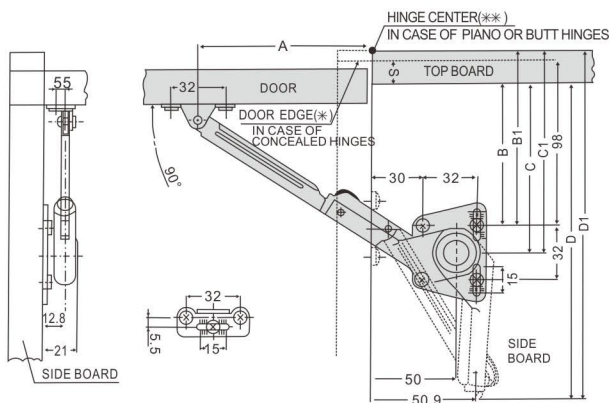

* The above and right drawings show for A587L (left-hand side mounting) and A587R comes symmetrically.

Depending on the type of the hinges used, the position of the mounting plate and arm fixing plate should be fixed as indicated below. The distance for A, B(B1), C(C1) is measured from "door edge (*)" and "underside of top board" in case European concealed hinges are used, and from "hinge center (**)" and "topside of top board" in case Piano or Butt Hinges are used.

FOR 90° ANGLE OPEN

	A	B	C	D	B1	C1	D1
CONCEALED HINGE	99	98 - S	114 - S	200.5 - S	—	—	—
BUTT HINGE OR PIANO HINGE	93	—	—	—	92	108	194.5

S=OVERLAY COVERAGE BY CONCEALED HINGES(MM)

When 80° or 100° opening is desired, move the mounting plate and arm fixing plate by sliding them in the oblong slots (7.5mm) as shown in the below drawings.

OPENING ANGLE	60°		90°		100°	
	DOWN		MIDDLE		UP	
POSITION OF PLATES	MOUNTING PLATE	ARM FIXING PLATE	MOUNTING PLATE	ARM FIXING PLATE	MOUNTING PLATE	ARM FIXING PLATE
FOR HINGE CENTER (UP)						
(DOWN)						

INSTALLATION PROCEDURE & SPEED ADJUSTMENT

Step-1

Mount the arm fixing plate on the back of the door at the correct position with screw - A.

Place the mounting plate on the side board by putting the screws - B in to the slots and fasten them temporarily. The oblong slotted side must be placed towards back of cabinet.

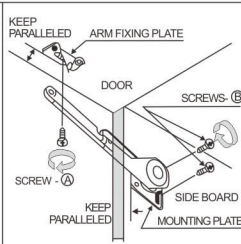

Step-2

Deciding the opening angle of door, loosen the screws in the slots, and adjust the position of the plates as shown in the above drawing in each case of opening angle. Then, fix them with the screw - A & B in the round holes of both plates.

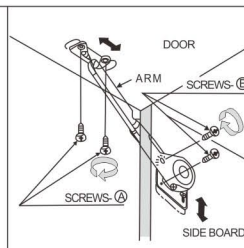

Step-3

Upon completing Step-2, rotate the body so that the hole of the arm's tip - C comes on to the position of the hole - D of the arm fixing plate. Then, fasten the arm and arm fixing plate with screw - E.

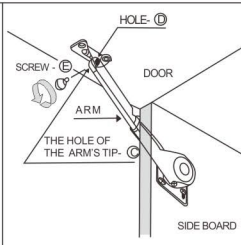

Speed adjustment

Upon completion of installation, make sure the door opens and closes properly. To adjust the closing speed of the door, turn the speed adjustment screw. In case 2 units (left & right) are turned evenly.

* Do not try to turn the speed adjustment screws exceeding their limitation.

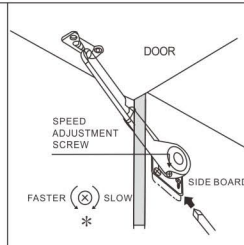

DOOR WEIGHT AND SIZE

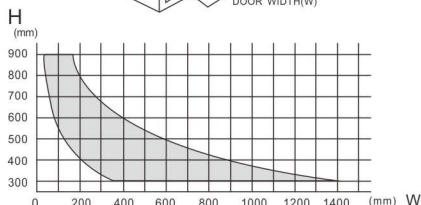
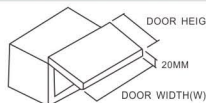

This product must be applied to a door with specific weight and size. Lined section of the graph indicates applicable door weight range based on 1 unit per door.

Note-1: In case of 2 units (right & left) per door

Door width (W) can be twice as large, if the door height (H) remains unchanged.

Note-2: In case of different door thickness or specific gravity, door weight range must fit the following formula.

* 1 unit per door: MIN. ~ MAX.

1/2 door height (cm) X door weight (kg): 16~70 kg · cm
 (1/2 door weight (inch) X door weight (lb): 12~60 lb · inch)

* 2 unit (right & left) per door: MIN. ~ MAX.

1/2 door height (cm) X door weight (kg): 32~140 kg · cm
 (1/2 door weight (inch) X door weight (lb): 24~120 lb · inch)

Note-3: European MDF door is heavier and of specific gravity 0.75 approx. By which the stay can cover about 30 percent less width in the lefthand graph.

● In case of a usual wooden flap of 20 mm thickness (specific gravity approx. 0.5)

WARNINGS

- * This product has damping function, and is designed for a relatively lightweight cabinet or furniture door. We will not be liable for any injuries or damage due to incorrect installation or use on a door that is not within limited torque moment.
- * This product is designed to operate at room temperatures between 0° C-40° C (32° F-104° F).
- * This product has a spring at the elbow section. Please be careful not to get your fingers caught in the elbow of the product while you are handling the unit.
- * Do not force the door to close faster. It can cause damage to the product or hinge(s).